

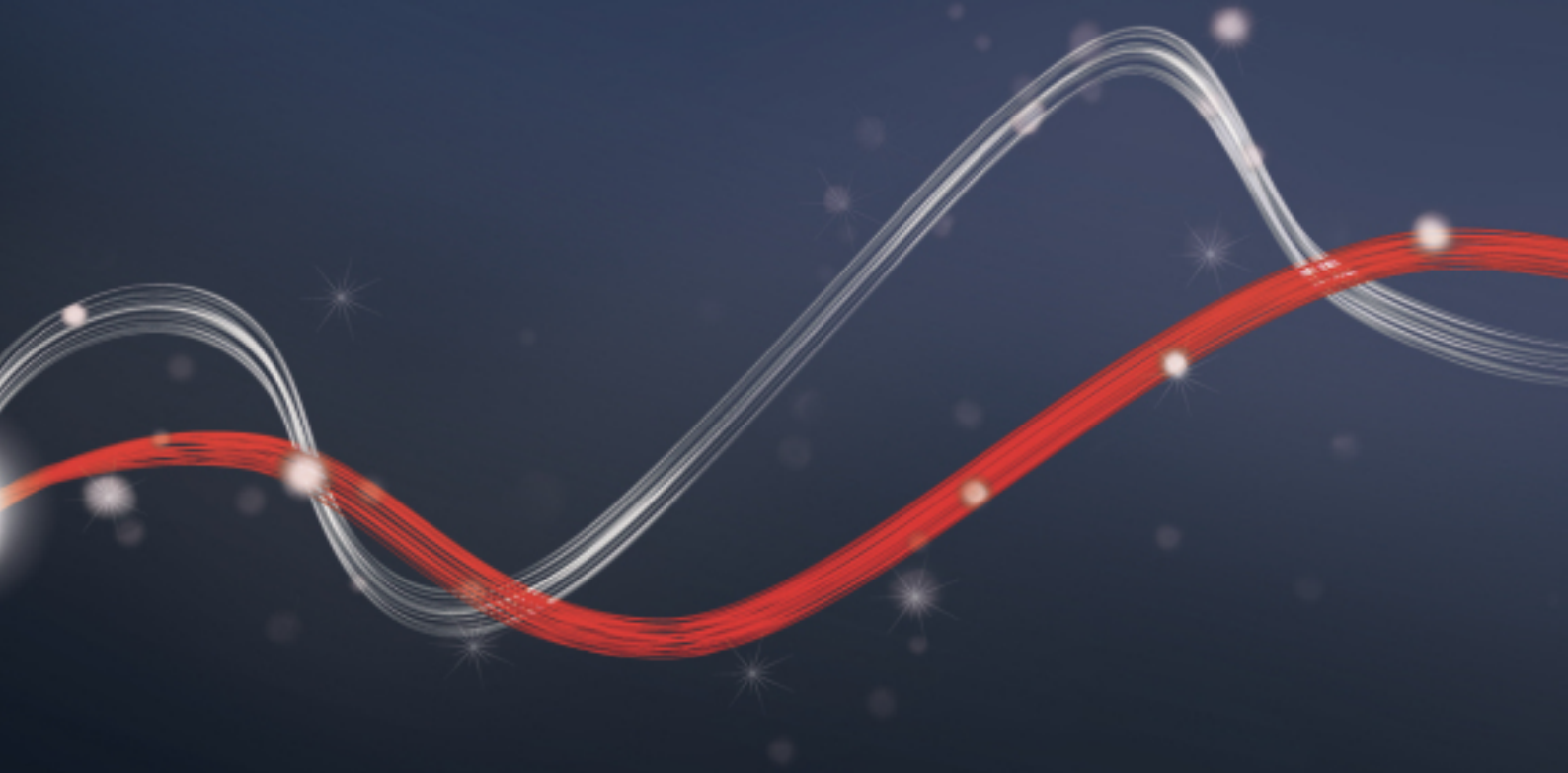

Be ahead



# DEIMOS ULTRA BT A



Product

PLUS

CONTROL UNIT  
TECHNICAL FEATURES

ACCESSORIES

DISCOVER U-LINK



- ee link
- 24 V
- er ready
- d-track
- U-Link



Range of operators for sliding gates weighing up to 600 Kg.  
Maximum leaf speed up to 16 m/min.

Newly designed magnetic limit switch for quicker installation; precise and perfectly integrated with architecture of site.

Residential use.

Control unit designed for use with the Blue Entry system.

**DEIMOS ULTRA BT A**

Code	Name	Description	
P925221 00002	DEIMOS ULTRA BT A400	Operator 24 V for sliding gates up to 400 kg in weight. Leaf speed 12 m/min. U-Link and magnetic limit switch	
P925221 00003	DEIMOS ULTRA BT A400 V	Operator 24 V for sliding gates up to 300 kg in weight. Leaf speed 16 m/min. U-Link and magnetic limit switch	
P925223 00002	DEIMOS ULTRA BT A600	Operator 24 V for sliding gates up to 600 kg in weight. Leaf speed 12 m/min. U-Link and magnetic limit switch	
P925223 00003	DEIMOS ULTRA BT A600 V	Operator 24 V for sliding gates up to 360 kg in weight. Leaf speed 16 m/min. U-Link and magnetic limit switch	
R925265 00002	DEIMOS ULTRA BT KIT A400 FRA	Complete kit 24 V for sliding gates weighing up to 400 kg. Leaf speed 12 m/min. Limit switch magnetic U-Link and magnetic limit switch	
R925269 00002	DEIMOS ULTRA BT KIT A600 FRA	Complete kit 24 V for sliding gates weighing up to 600 kg. Leaf speed 12 m/min. Limit switch magnetic U-Link and magnetic limit switch	

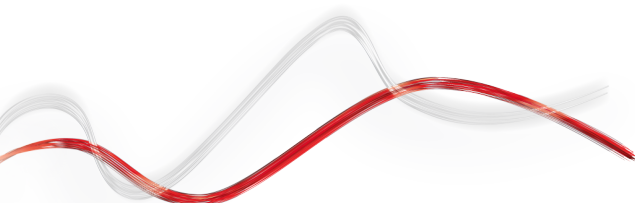

· Product

· PLUS

· CONTROL UNIT  
· TECHNICAL FEATURES

· ACCESSORIES

· DISCOVER U-LINK

## PLUS



**Magnetic limit switches:** this type of limit switch ensures safe and precise installations in any ambient condition



**Control unit with programming display:** the Merak control unit with programming display with pre-programmed scenarios helps the installer in the programming phase; the control unit is arranged in an oblique way, to facilitate reading and making the settings.



**Front screws:** this arrangement of the casing screws offers ease and convenience during installation and maintenance, even when there is limited space.



**Release lever with personalised key:** the release lever simplifies motor release and the personalized key ensures its uniqueness, for better safety

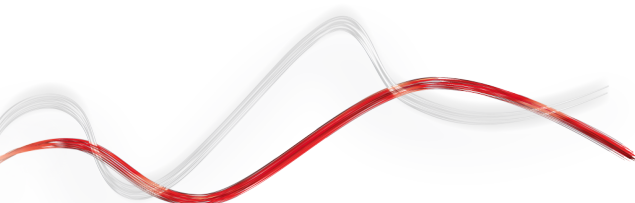

• Product

• PLUS

• **CONTROL UNIT**  
• **TECHNICAL FEATURES**

• ACCESSORIES

• DISCOVER U-LINK

## MERAK MERAK Built-In

### Incorporated control unit for one 24V operator for sliding gates



- Incorporated control unit for one 24V operator for sliding gates
- Board power supply: 230V single-phase
- Operator power supply: 24V 80W
- Main characteristics: removable terminal boards with the new colour standard, simplified programming with scenario display, integrated two-channel receiver, D-Track based antisquashing system and slowdown during opening or closing.
- Main functions: automatic closing, quick closing, pedestrian passage, people-present operation, maintenance warnings.
- Compatibility: HQSC-D, QSC-D MA

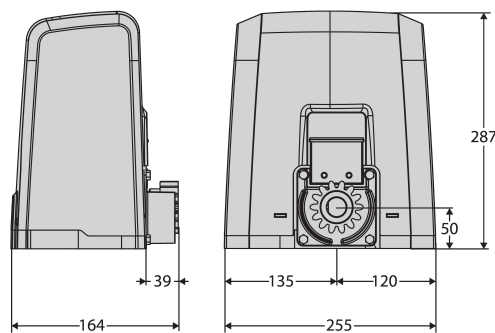

	DEIMOS ULTRA BT A400	DEIMOS ULTRA BT A400 V	DEIMOS ULTRA BT A600	DEIMOS ULTRA BT A600 V
Control unit	MERAK SL1		MERAK SL2	
Power supply	24 V			
Power input	50 W		70 W	
Type of limit switch	magnetic			
Pinion module	4			
Slowdown	yes			
Locking	mechanical			
Release	lever-operated with personal key			
Frequency of use	intensive			
Environmental conditions	from -20 °C to 55 °C			
Protection rating	IP44			
Actuator weight	7 kg		8 kg	
Impact reaction	d-track			

· Product

· PLUS

· CONTROL UNIT  
· TECHNICAL FEATURES

· **ACCESSORIES**

· DISCOVER U-LINK

	Code	Name	Description
	D221073	CP	Plastic rack, 4-module, cross-section 22 x 22 mm, length 1 m, screw-fitted into slots
	N999151	SFD	Base plate for DEIMOS series (supplied with operator) Base plate for DEIMOS series (supplied with operator)
	N190104	BIR C	Rubber safety edge (H 30 mm), price per m
	D111904	MITTO B RCB02 R1	Transmitter with 2 channels. Range 50/100 m. Power supply 12 V with 1 battery type 23 A
	P121016	RB	4-channel wall-mounted radio control with rolling code
	D113748 00003	RADIUS B LTA 24 R1	Flashing light with incorporated antenna for motors with power supply 24 V.
	D113749 00003	RADIUS B LTA 24 R2	Flashing light without incorporated antenna for motors with power supply 24 V.
	D113783	IPNOS B LTB 24 R1	Flashing light with LED technology and built-in receiver antenna. New design language with smoke-grey cover. Power supply 24 V ac/dc.
	P123025	B 00 R02	Wall mounting for B LTA series flashing beacons
	P123026	B 00 R01	Metal guard for B LTA
	P121024	Q.BO TOUCH	Wireless digital touchpad with 433MHz rolling code operation. Manages up to 10 channels and 100 codes.
	P121022	Q.BO KEY WM	Key selector for outdoor use with double contact. Key selector for outdoor use with double contact.
	P111528	THEA A15 O.PF	Pair of adjustable photocells with integrated flashing light. Possibility of directing the beam 40 ° horizontally and 10 ° vertically. IR signal synchronised to prevent any risk of blinding. Range 30 m. Power supply 24 V ac/dc. For external application.
	P111526	DESME A15	Pair of self-aligning photocells. Range 30 m. Power supply 24 V ac/dc. Pair of self-aligning photocells. Range 30 m. Power supply 24 V ac/dc.
	P111527	DESME A15 O	Pair of photocells adjustable 40 ° horizontally and 10 ° vertically. IR signal synchronised to prevent any risk of blinding. Range 30 m. Power supply 24 V ac/dc.







· Product

· PLUS

· CONTROL UNIT  
· TECHNICAL FEATURES

· **ACCESSORIES**

· DISCOVER U-LINK

	Code	Name		Description
	P903018	<b>PHP</b>		Pair of aluminium posts for THEA/DESME series photocells Height 522 mm
	P111468	<b>B EBA RS 485 LINK</b>		Expansion board for connection of central units with serial controls management
	P111531	<b>B EBA BLUE ENTRY ANDROID 4</b>		BLUE-TOOTH expansion card for Blue Entry system. Manages up to 4 smartphones with the Android operating system
	P125035	<b>SL BAT2</b>		Emergency battery kit for Deimos BT A, Ares BT A, Deimos Ultra BT A, Ares Ultra BT A.

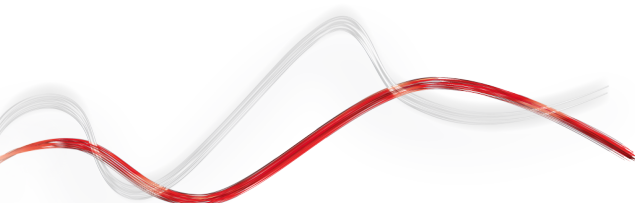



· Product

· PLUS

· CONTROL UNIT  
· TECHNICAL FEATURES

· ACCESSORIES

· DISCOVER U-LINK

## What is U-Link?

The innovative technology that gives you new power

An exclusive Bft innovation: U-Link (Universal Link) is an exclusive Bft platform that allows the creation of technological ecosystems. In Home Automation Access, it allows communication with all the home access automation devices of any brand. So you save time and can control everything with ease, without any worries.

### It is intuitive

Easy to install and use

### It is scalable

Allows an unlimited number of devices to be added

### It is flexible

Allows the creation of groups of interconnected products

### It is practical

Works with or without a web connection

### It is functional

Parameters can be controlled remotely via dedicated applications

· Product

· PLUS

· CONTROL UNIT  
· TECHNICAL FEATURES

· ACCESSORIES

· **DISCOVER U-LINK**

## All in one scheme: discover this amazing technology

A unique platform **allowing the creation of technological ecosystems** offering a wide range of solutions for different sectors.

Thanks to the B-Eba cards and the Clonix U-Link receiver, this proprietary platform featured by Bft products adapts to any protocol and access automation product (even BFT, non-native U-Link or non-BFT products), and is used in various sectors. Each device thus becomes smart and can be interconnected with other systems, thanks to a language that becomes universal.

### U-Base 2



Software to install and easily and comfortably carry out maintenance and identify any malfunction of U-link compatible operators.

### U-SDK



U-SDK is the innovative application that can make Bft automation systems compatible and easily integrated with a BMS network for the supervision of buildings.



### Magistro

An innovative and easy to install system for easily managing all home automation systems.



### U-Control

U-Control is the application that helps the quick and easy integration of BFT automation systems in large building management systems.



### Blue-Entry

Technology abreast of the times and attentive to daily needs: thanks to the use of U-link the house gate can now be opened with just your smartphone.



### Clonix U-Link

Allows the connection of non-native U-Link products or non-Bft products to U-Link systems.

Bft operators, non-native U-Link products or a product belonging to other brands: can they be connected to U-Link? Yes, thanks to the Clonix receivers. Accessories that know no limits.

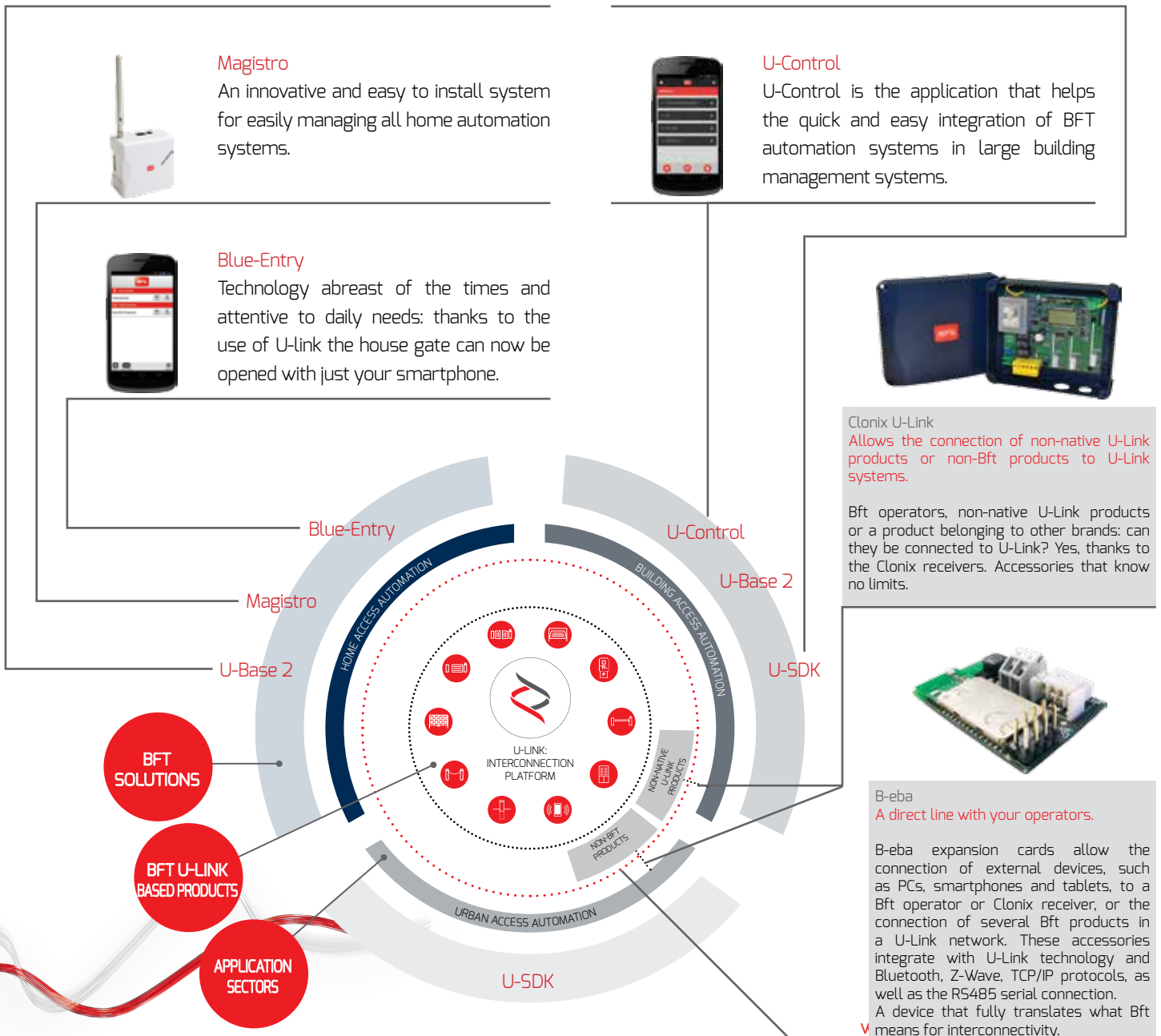

### B-Eba

A direct line with your operators.

B-Eba expansion cards allow the connection of external devices, such as PCs, smartphones and tablets, to a Bft operator or Clonix receiver, or the connection of several Bft products in a U-Link network. These accessories integrate with U-Link technology and Bluetooth, Z-Wave, TCP/IP protocols, as well as the RS485 serial connection.

A device that fully translates what Bft means for interconnectivity.





INFORMATION REGARDING THE PROTECTION OF THE INDUSTRIAL AND INTELLECTUAL PROPERTY RIGHTS OF BFT. BFT S.p.A. protects its industrial property by depositing trademarks, patents, models and designs. The intellectual property of BFT S.p.A. is protected by copyright law. BFT S.p.A. also protects its know-how by taking measures to protect the technical and commercial information inherent in its company and products. All the products in this catalogue are ORIGINAL BFT MODELS and only BFT S.p.A is authorised to produce them and market them anywhere in the world. All the commercial names in this catalogue are owned by BFT S.p.A., and only BFT S.p.A. is authorised to use them in relation to the corresponding merchandise category. FALSIFIERS WILL BE PROCEEDED AGAINST IN ACCORDANCE WITH BOTH CIVIL AND CRIMINAL LAW. THESE CONDITIONS NOT ONLY GUARANTEE THE INTELLECTUAL PROPERTY RIGHTS OF BFT, BUT ALSO PROTECT CUSTOMERS BY GUARANTEEING THAT THE PRODUCTS THEY ARE PURCHASING ARE ORIGINAL BFT PRODUCTS RESULTING FROM STUDIES AND DESIGNS WITHIN THE BFT COMPANY.